

BY	CHK	REVISION RECORD MODIFICATIONS	DATE	REV.
ALLEN		RELEASE TO PRODUCTION	2007,9,10	1.0

**SPECIFICATION**

Current Rate: 1 AMP  
 Insulation Resistance: 2000mΩ Min  
 Contact Resistance: 20mΩ Max  
 Dielectric voltage: 500V AC for one minute  
 Operation Temperature: -55°C to +105°C

**MATERIAL**

Insulator: High Temperature Plastic UL-94V-0 Nature Color  
 Contact: Phosphor Bronze  
 Contact Plating: Gold on Contact Area, and Tin plated or nickel plated  
 Metal Board Lock: Copper Alloy with Tin Plating  
 Shell: Zinc Alloy with Nickel Plating

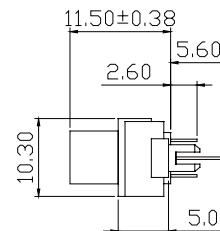
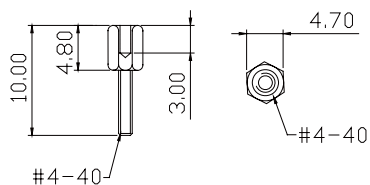
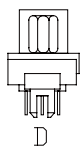
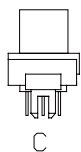
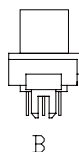
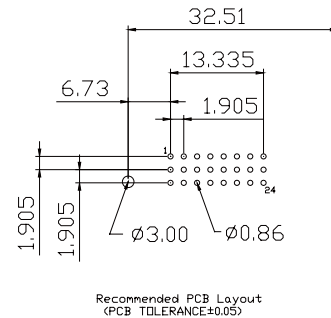
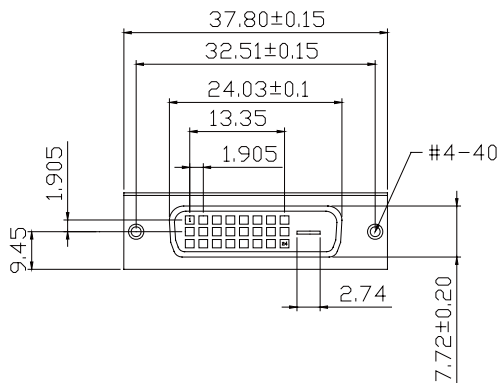
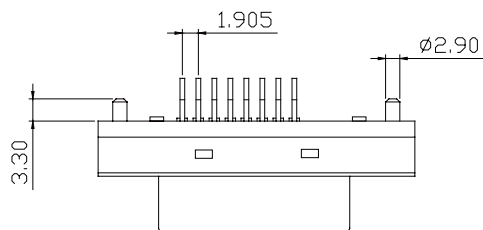

**ORDER INFORMATION**

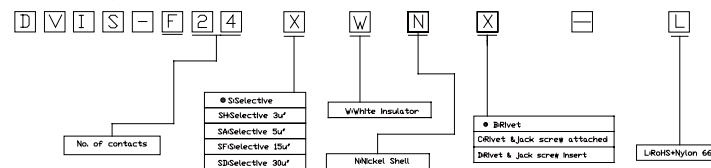

APPRO	CHECK	DRAWN	PART NO.	DVIS-F24XWNL			DESCRIPTION	
			ITEM NO.					
			DRAW NO.					
			UNIT	mm	SCALE	no		
			TOLER		NO.			
Tel: 0769 22020068 Fax: 0769 22020069 E-mail: sales@vigortec.com								